

# FOD814 Series, FOD617 Series, FOD817 Series 4-Pin Phototransistor Optocouplers

## Features

- AC input response (FOD814 only)
- Applicable to Pb-free IR reflow soldering
- Compact 4-pin package
- Current transfer ratio in selected groups:
 

FOD617A: 40–80%	FOD817: 50–600%
FOD617B: 63–125%	FOD817A: 80–160%
FOD617C: 100–200%	FOD817B: 130–260%
FOD617D: 160–320%	FOD817C: 200–400%
FOD814: 20–300%	FOD817D: 300–600%
FOD814A: 50–150%	
- C-UL, UL and VDE approved
- High input-output isolation voltage of 5000Vrms
- Higher operating temperatures (versus FODXXX counterparts)
- Minimum  $BV_{CEO}$  of 70V guaranteed

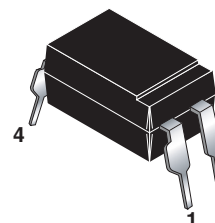
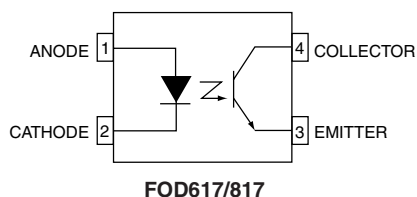
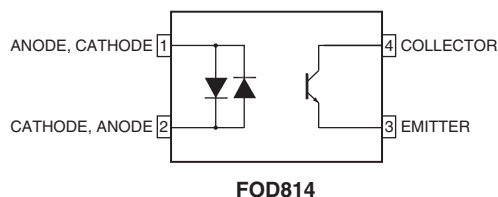
## Applications

- FOD814 Series
- AC line monitor
  - Unknown polarity DC sensor
  - Telephone line interface
- FOD617 and FOD817 Series
- Power supply regulators
  - Digital logic inputs
  - Microprocessor inputs

## Description

The FOD814 consists of two gallium arsenide infrared emitting diodes, connected in inverse parallel, driving a silicon phototransistor output in a 4-pin dual in-line package. The FOD617/817 Series consists of a gallium arsenide infrared emitting diode driving a silicon phototransistor in a 4-pin dual in-line package.

## Functional Block Diagram



**Absolute Maximum Ratings** ( $T_A = 25^\circ\text{C}$  Unless otherwise specified.)

Parameter	Symbol	Value		Units
		FOD814	FOD617/817	
<b>TOTAL DEVICE</b>				
Storage Temperature	$T_{STG}$	-55 to +150		$^\circ\text{C}$
Operating Temperature	$T_{OPR}$	-55 to +105	-55 to +110	$^\circ\text{C}$
Lead Solder Temperature	$T_{SOL}$	260 for 10 sec		$^\circ\text{C}$
Total Power Dissipation	$P_{TOT}$	200		mW
<b>EMITTER</b>				
Continuous Forward Current	$I_F$	$\pm 50$	50	mA
Reverse Voltage	$V_R$	—	6	
Power Dissipation Derate above $100^\circ\text{C}$	$P_D$	70 1.7		mW mW/ $^\circ\text{C}$
<b>DETECTOR</b>				
Collector-Emitter Voltage	$V_{CEO}$	70		V
Emitter-Collector Voltage	$V_{ECO}$	6	6 (FOD817) 7 (FOD617)	V
Continuous Collector Current	$I_C$	50		mA
Collector Power Dissipation Derate above $90^\circ\text{C}$	$P_C$	150 2.9		mW mW/ $^\circ\text{C}$

**Electrical/Characteristics** ( $T_A = 25^\circ\text{C}$  Unless otherwise specified.)

**Individual Component Characteristics**

Parameter	Device	Test Conditions	Symbol	Min	Typ*	Max	Unit
<b>EMITTER</b>							
Forward Voltage	FOD814 FOD617 FOD817	( $I_F = \pm 20\text{ mA}$ ) ( $I_F = 60\text{ mA}$ ) ( $I_F = 20\text{ mA}$ )	$V_F$	— — —	1.2 1.35 1.2	1.4 1.65 1.4	V
Reverse Leakage Current	FOD617 FOD817	( $V_R = 6.0\text{ V}$ ) ( $V_R = 4.0\text{ V}$ )	$I_R$	— —	0.001 —	10 10	$\mu\text{A}$
Terminal Capacitance	FOD814 FOD617 FOD817	( $V = 0, f = 1\text{ kHz}$ ) ( $V = 0, f = 1\text{ kHz}$ ) ( $V = 0, f = 1\text{ kHz}$ )	$C_t$	— — —	50 30 30	250 250 250	pF
<b>DETECTOR</b>							
Collector Dark Current	FOD814 FOD617C/ D FOD617A/ B FOD817	( $V_{CE} = 20\text{ V}, I_F = 0$ ) ( $V_{CE} = 10\text{ V}, I_F = 0$ ) ( $V_{CE} = 10\text{ V}, I_F = 0$ ) ( $V_{CE} = 20\text{ V}, I_F = 0$ )	$I_{CEO}$	— — — —	— 1 1 —	100 100 50 100	nA
Collector-Emitter Breakdown Voltage	FOD814 FOD617 FOD817	( $I_C = 0.1\text{ mA}, I_F = 0$ ) ( $I_C = 100\text{ }\mu\text{A}, I_F = 0$ ) ( $I_C = 0.1\text{ mA}, I_F = 0$ )	$BV_{CEO}$	70 70 70	— — —	— — —	V
Emitter-Collector Breakdown Voltage	FOD814 FOD617 FOD817	( $I_E = 10\text{ }\mu\text{A}, I_F = 0$ ) ( $I_E = 10\text{ }\mu\text{A}, I_F = 0$ ) ( $I_E = 10\text{ }\mu\text{A}, I_F = 0$ )	$BV_{ECO}$	6 7 6	— — —	— — —	V

**Transfer Characteristics** ( $T_A = 25^\circ\text{C}$  Unless otherwise specified.)

DC Characteristic	Device	Test Conditions	Symbol	Min	Typ*	Max	Unit
Current Transfer Ratio	FOD814	$I_F = \pm 1\text{ mA}, V_{CE} = 5\text{ V}^1$	CTR	20	—	300	%
	FOD814A			50	—	150	
	FOD617A	$I_F = 10\text{ mA}, V_{CE} = 5\text{ V}^1$		40	—	80	
	FOD617B			63	—	125	
	FOD617C			100	—	200	
	FOD617D			160	—	320	
	FOD617A	$I_F = 1\text{ mA}, V_{CE} = 5\text{ V}^1$		13	—	—	
	FOD617B			22	—	—	
	FOD617C			34	—	—	
	FOD617D			56	—	—	
	FOD817	$I_F = 5\text{ mA}, V_{CE} = 5\text{ V}^1$		50	—	600	
	FOD817A			80	—	160	
	FOD817B			130	—	260	
	FOD817C			200	—	400	
	FOD817D			300	—	600	
Collector-Emitter Saturation Voltage	FOD814	$I_F = \pm 20\text{ mA}, I_C = 1\text{ mA}$	$V_{CE(sat)}$	—	0.1	0.2	V
	FOD617	$I_F = 10\text{ mA}, I_C = 2.5\text{ mA}$		—	—	0.4	
	FOD817	$I_F = 20\text{ mA}, I_C = 1\text{ mA}$		—	0.1	0.2	
Cut-Off Frequency	FOD814	$V_{CE} = 5\text{ V}, I_C = 2\text{ mA}, R_L = 100\text{ }\Omega, -3\text{ dB}$	$f_C$	15	80	—	KHz

\*Typical values at  $T_A = 25^\circ\text{C}$

**Transfer Characteristics (continued)** ( $T_A = 25^\circ\text{C}$  Unless otherwise specified.)

AC Characteristic	Device	Test Conditions	Symbol	Min	Typ*	Max	Unit
Response Time (Rise)	FOD814 FOD617 FOD817	$V_{CE} = 2\text{ V}, I_C = 2\text{ mA}, R_L = 100\ \Omega^2$	$t_r$	—	4	18	$\mu\text{s}$
Response Time (Fall)	FOD814 FOD617 FOD817		$t_f$	—	3	18	$\mu\text{s}$

**Isolation Characteristics**

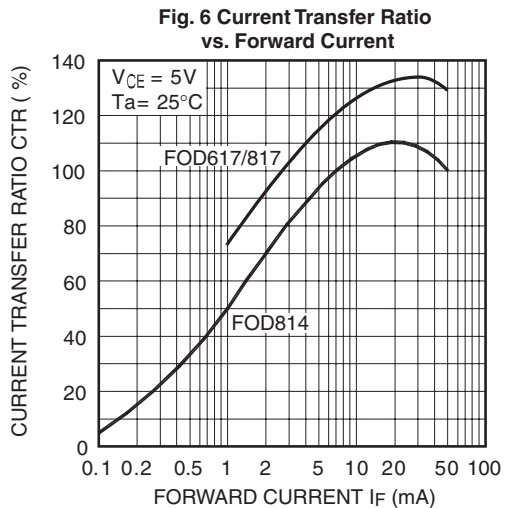
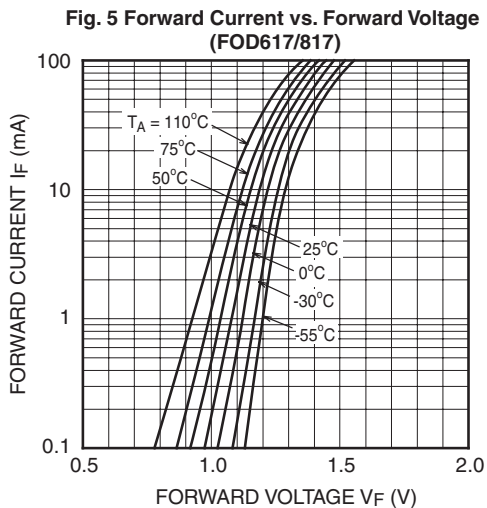
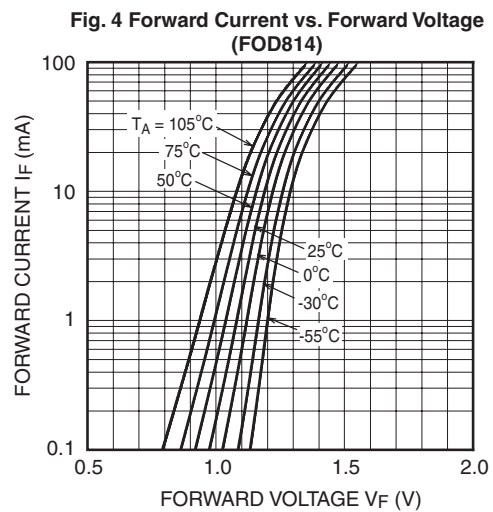
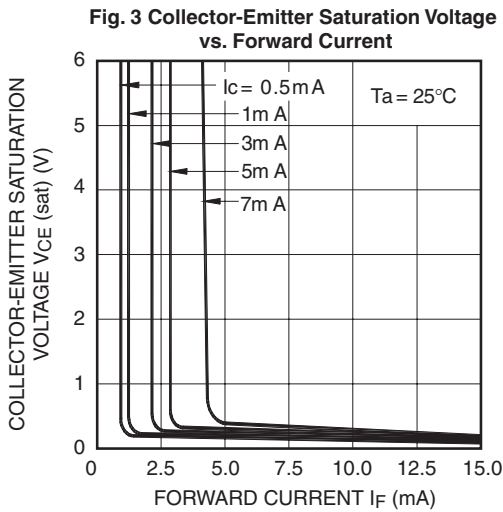
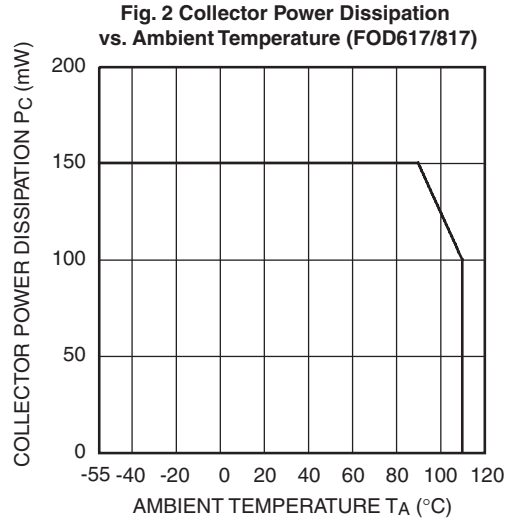
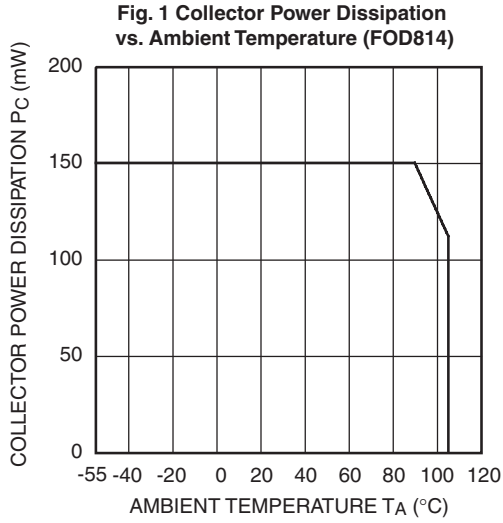
Characteristic	Device	Test Conditions	Symbol	Min	Typ*	Max	Units
Input-Output Isolation Voltage <sup>3</sup>	FOD814	$f = 60\text{ Hz}, t = 1\text{ min}$	$V_{ISO}$	5000			Vac(rms)
	FOD617						
	FOD817						
Isolation Resistance	FOD814	$V_{I-O} = 500\text{ VDC}$	$R_{ISO}$	$5 \times 10^{10}$	$1 \times 10^{11}$	—	$\Omega$
	FOD617						
	FOD817						
Isolation Capacitance	FOD814	$V_{I-O} = 0, f = 1\text{ MHz}$	$C_{ISO}$		0.6	1.0	pf
	FOD617						
	FOD817						

\*Typical values at  $T_A = 25^\circ\text{C}$

**Notes**

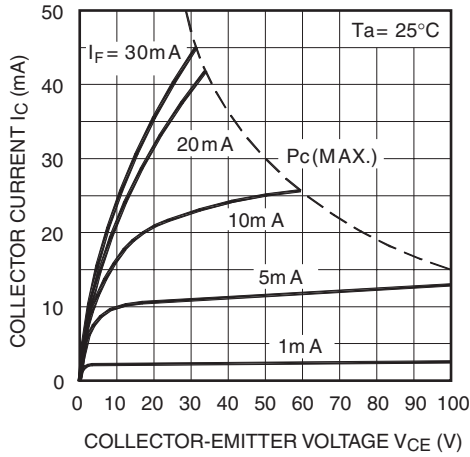
1. Current Transfer Ratio (CTR) =  $I_C/I_F \times 100\%$ .
2. For test circuit setup and waveforms, refer to page 4.
3. For this test, Pins 1 and 2 are common, and Pins 3 and 4 are common.

**Typical Electrical/Optical Characteristic Curves** ( $T_A = 25^\circ\text{C}$  Unless otherwise specified.)

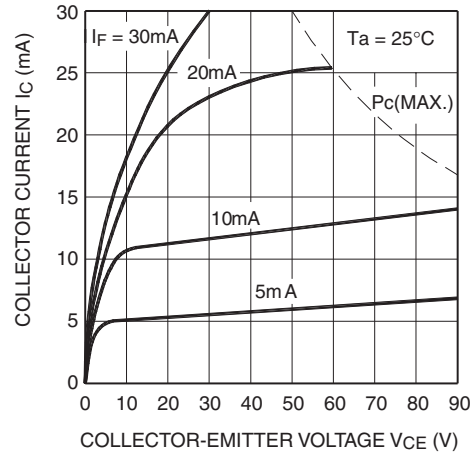


**Typical Electrical/Optical Characteristic Curves** ( $T_A = 25^\circ\text{C}$  Unless otherwise specified.)

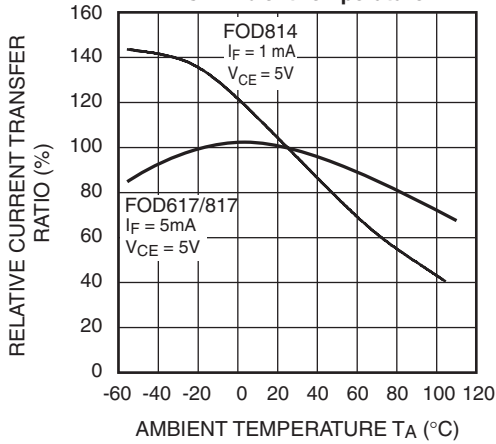
**Fig. 7 Collector Current vs. Collector-Emitter Voltage (FOD814)**



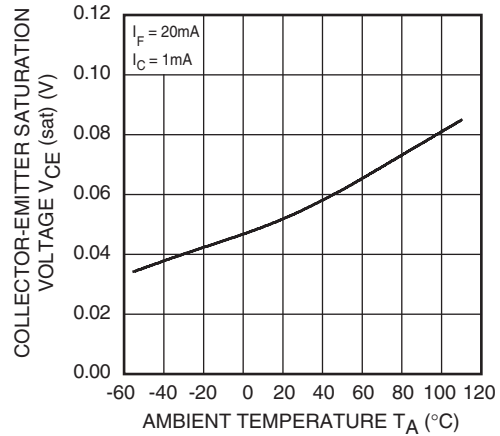
**Fig. 8 Collector Current vs. Collector-Emitter Voltage (FOD617/817)**



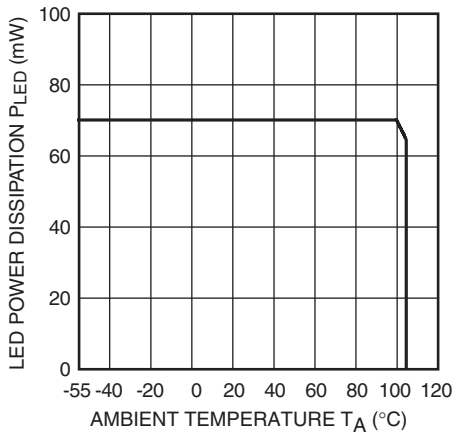
**Fig. 9 Relative Current Transfer Ratio vs. Ambient Temperature**



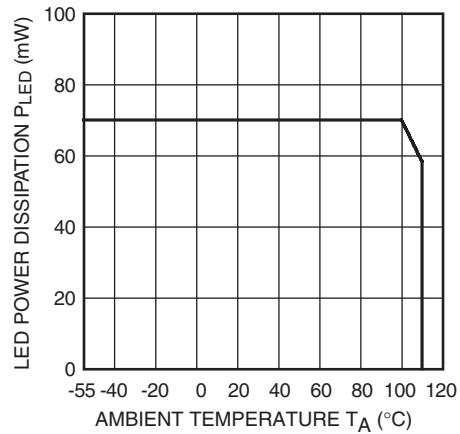
**Fig. 10 Collector-Emitter Saturation Voltage vs. Ambient Temperature**



**Fig. 11 LED Power Dissipation vs. Ambient Temperature (FOD814)**

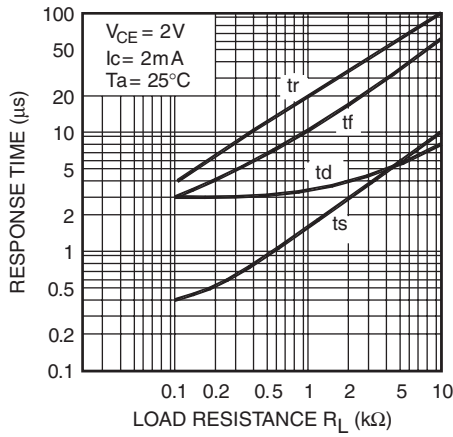


**Fig. 12 LED Power Dissipation vs. Ambient Temperature (FOD617/817)**

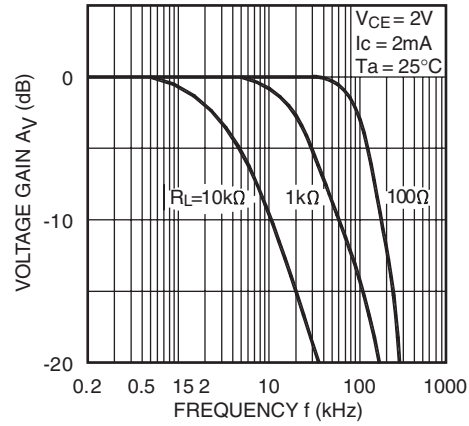


**Typical Electrical/Optical Characteristic Curves** ( $T_A = 25^\circ\text{C}$  Unless otherwise specified.)

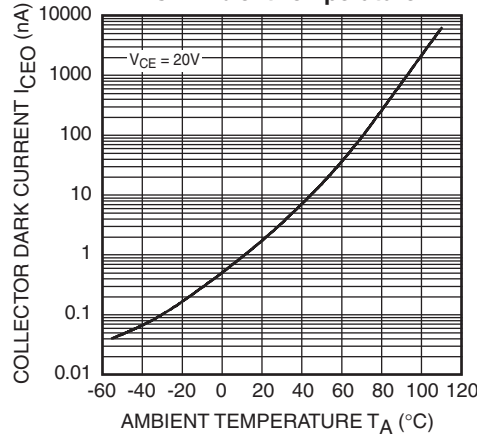
**Fig. 13 Response Time vs. Load Resistance**



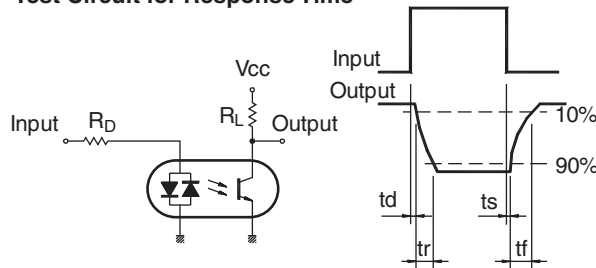
**Fig. 14 Frequency Response**



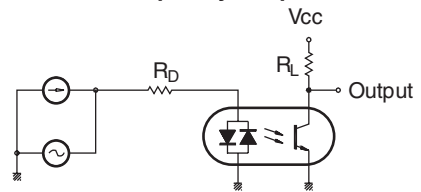
**Fig. 15 Collector Dark Current vs. Ambient Temperature**



**Test Circuit for Response Time**



**Test Circuit for Frequency Response**



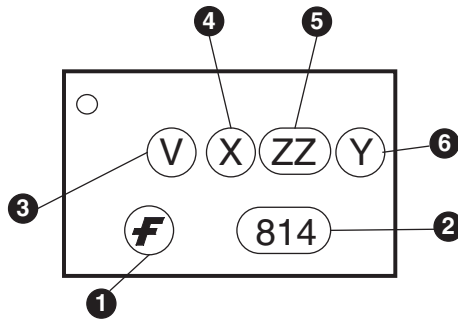




### Ordering Information

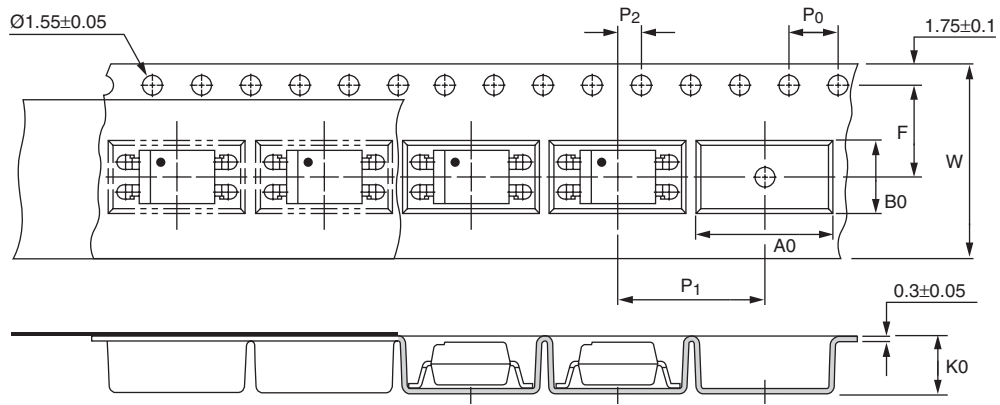
Option	Part Number Example	Description
S	FOD814S	Surface Mount Lead Bend
SD	FOD814SD	Surface Mount; Tape and reel
W	FOD814W	0.4" Lead Spacing
300	FOD814300	VDE Approved
300W	FOD814300W	VDE Approved, 0.4" Lead Spacing
3S	FOD8143S	VDE Approved, Surface Mount
3SD	FOD8143SD	VDE Approved, Surface Mount, Tape & Reel

### Marking Information



Definitions	
1	Fairchild logo
2	Device number
3	VDE mark (Note: Only appears on parts ordered with VDE option – See order entry table)
4	One digit year code
5	Two digit work week ranging from '01' to '53'
6	Assembly package code

### Carrier Tape Specifications

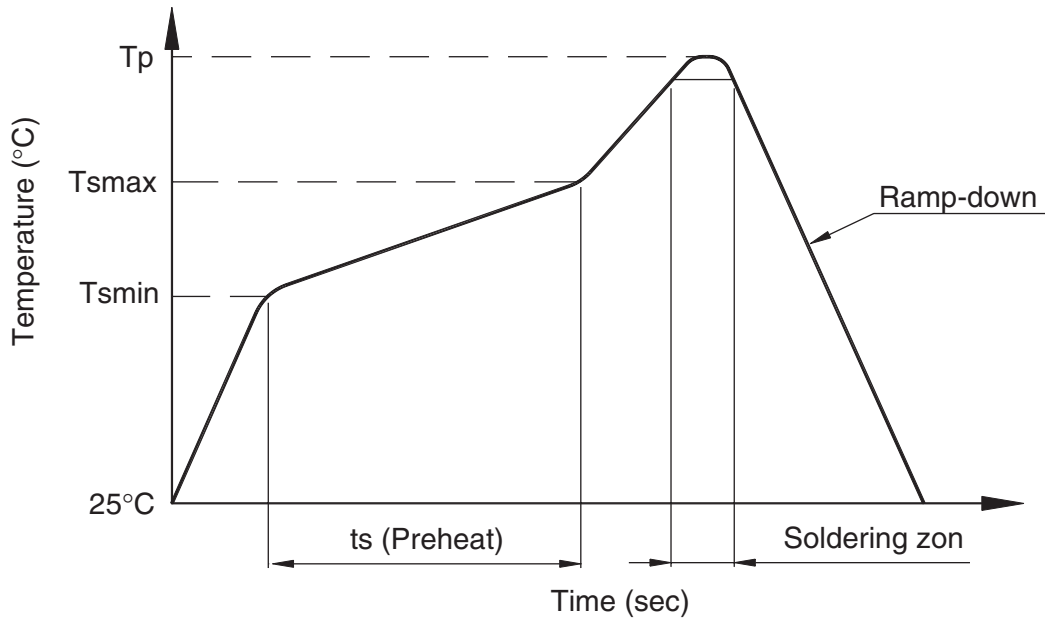


**NOTE**

All dimensions are in millimeters

Description	Symbol	Dimensions in mm (inches)
Tape wide	W	$16 \pm 0.3$ (.63)
Pitch of sprocket holes	$P_0$	$4 \pm 0.1$ (.15)
Distance of compartment	F	$7.5 \pm 0.1$ (.295)
	$P_2$	$2 \pm 0.1$ (.079)
Distance of compartment to compartment	$P_1$	$12 \pm 0.1$ (.472)
Compartment	$A_0$	$10.45 \pm 0.1$ (.411)
	$B_0$	$5.30 \pm 0.1$ (.209)
	$K_0$	$4.25 \pm 0.1$ (.167)

**Lead Free recommended IR Reflow condition**



Profile Feature	Pb-Sn solder assembly	Lead Free assembly
Preheat condition (Tsmín-Tsmáx / ts)	100°C ~ 150°C 60 ~ 120 sec	150°C ~ 200°C 60 ~ 120 sec
Melt soldering zone	183°C 60 ~ 120 sec	217°C 30 ~ 90 sec
Peak temperature (Tp)	240 +0/-5°C	260 +0/-5°C
Ramp-down rate	6°C/sec max.	6°C/sec max.

**Recommended Wave Soldering condition**

Profile Feature	For all solder assembly
Peak temperature (Tp)	Max 260°C for 10 sec

## TRADEMARKS

The following are registered and unregistered trademarks Fairchild Semiconductor owns or is authorized to use and is not intended to be an exhaustive list of all such trademarks.

ACEx™	FAST®	ISOPLANAR™	PowerSaver™	SuperSOT™-6
ActiveArray™	FASTr™	LittleFET™	PowerTrench®	SuperSOT™-8
Bottomless™	FPST™	MICROCOUPLER™	QFET®	SyncFET™
Build it Now™	FRFET™	MicroFET™	QS™	TinyLogic®
CoolFET™	GlobalOptoisolator™	MicroPak™	QT Optoelectronics™	TINYOPTO™
CROSSVOLT™	GTO™	MICROWIRE™	Quiet Series™	TruTranslation™
DOME™	HiSeC™	MSX™	RapidConfigure™	UHC™
EcoSPARK™	I <sup>2</sup> C™	MSXPro™	RapidConnect™	UltraFET®
E <sup>2</sup> CMOS™	i-Lo™	OCX™	μSerDes™	UniFET™
EnSigna™	ImpliedDisconnect™	OCXPro™	ScalarPump™	VCX™
FACT™	IntelliMAX™	OPTOLOGIC®	SILENT SWITCHER®	Wire™
FACT Quiet Series™		OPTOPLANAR™	SMART START™	
Across the board. Around the world.™		PACMAN™	SPM™	
The Power Franchise®		POP™	Stealth™	
Programmable Active Droop™		Power247™	SuperFET™	
		PowerEdge™	SuperSOT™-3	

## DISCLAIMER

FAIRCHILD SEMICONDUCTOR RESERVES THE RIGHT TO MAKE CHANGES WITHOUT FURTHER NOTICE TO ANY PRODUCTS HEREIN TO IMPROVE RELIABILITY, FUNCTION OR DESIGN. FAIRCHILD DOES NOT ASSUME ANY LIABILITY ARISING OUT OF THE APPLICATION OR USE OF ANY PRODUCT OR CIRCUIT DESCRIBED HEREIN; NEITHER DOES IT CONVEY ANY LICENSE UNDER ITS PATENT RIGHTS, NOR THE RIGHTS OF OTHERS.

## LIFE SUPPORT POLICY

FAIRCHILD'S PRODUCTS ARE NOT AUTHORIZED FOR USE AS CRITICAL COMPONENTS IN LIFE SUPPORT DEVICES OR SYSTEMS WITHOUT THE EXPRESS WRITTEN APPROVAL OF FAIRCHILD SEMICONDUCTOR CORPORATION. As used herein:

1. Life support devices or systems are devices or systems which, (a) are intended for surgical implant into the body, or (b) support or sustain life, or (c) whose failure to perform when properly used in accordance with instructions for use provided in the labeling, can be reasonably expected to result in significant injury to the user.
2. A critical component is any component of a life support device or system whose failure to perform can be reasonably expected to cause the failure of the life support device or system, or to affect its safety or effectiveness.

## PRODUCT STATUS DEFINITIONS

### Definition of Terms

Datasheet Identification	Product Status	Definition
Advance Information	Formative or In Design	This datasheet contains the design specifications for product development. Specifications may change in any manner without notice.
Preliminary	First Production	This datasheet contains preliminary data, and supplementary data will be published at a later date. Fairchild Semiconductor reserves the right to make changes at any time without notice in order to improve design.
No Identification Needed	Full Production	This datasheet contains final specifications. Fairchild Semiconductor reserves the right to make changes at any time without notice in order to improve design.
Obsolete	Not In Production	This datasheet contains specifications on a product that has been discontinued by Fairchild semiconductor. The datasheet is printed for reference information only.

Rev. 117