

High Power SPT⁺ & Lugged Type IGBT Module

Description

DAWIN'S IGBT 7DM-1 Package devices are optimized to reduce losses and switching noise in high frequency power conditioning electrical systems. These IGBT modules are ideally suited for power inverters, motors drives and other applications where switching losses are significant portion of the total losses.

Features

- ☞ High Speed Switching
- ☞ $BV_{CES} = 1200V$
- ☞ Low Conduction Loss : $V_{CE(sat)} = 1.8V$ (typ.)
- ☞ Fast & Soft Anti-Parallel FWD
- ☞ Short circuit rated : Min. 10uS at $T_C=100^\circ C$
- ☞ Reduced EMI and RFI
- ☞ Isolation Type Package

Applications

Motor Drives, High Power Inverters, Welding Machine, Induction Heating, UPS , CVCF, Robotics , Servo Controls

Equivalent Circuit and Package

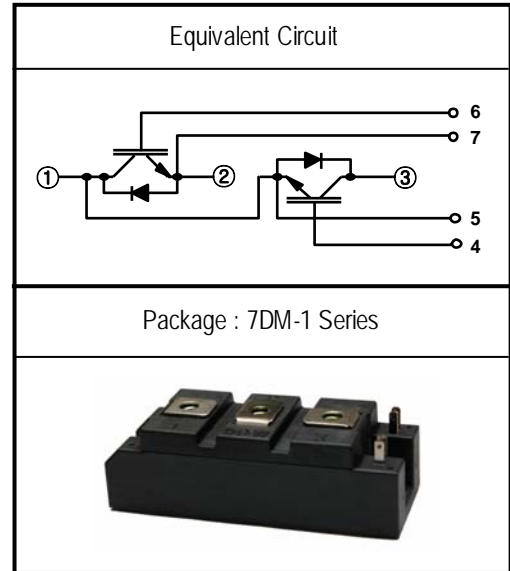

Please see the package out line information

Absolute Maximum Ratings @ $T_j=25^\circ C$ (Per Leg)

Symbol	Parameter	Conditions	Ratings	Unit
V_{CES}	Collector-Emitter Voltage	-	1200	V
V_{GES}	Gate-Emitter Voltage	-	± 20	V
I_C	Collector Current	$T_C = 25^\circ C$	150	A
		$T_C = 80^\circ C$	100	A
$I_{CM(1)}$	Pulsed Collector Current	-	200	A
I_F	Diode Continuous Forward Current	$T_C = 100^\circ C$	75	A
I_{FM}	Diode Maximum Forward Current	-	150	A
T_{SC}	Short Circuit Withstand Time	$T_C = 100^\circ C$	10	uS
P_D	Maximum Power Dissipation	$T_C = 25^\circ C$	700	W
T_j	Operating Junction Temperature	-	-40 ~ 150	$^\circ C$
T_{stg}	Storage Temperature Range	-	-40 ~ 125	$^\circ C$
V_{iso}	Isolation Voltage	AC 1 minute	2500	V
	Mounting screw Torque :M6	-	4.0	N.m
	Power terminals screw Torque :M5	-	2.0	N.m

Electrical Characteristics of IGBT @ $T_C=25^\circ\text{C}$ (unless otherwise specified)

Symbol	Parameter	Conditions	Values			Unit
			Min.	Typ.	Max.	
BV_{CES}	C - E Breakdown Voltage	$V_{GE} = 0V, I_C = 1.0mA$	1200	-	-	V
$\Delta BV_{CES}/\Delta T_J$	Temperature Coeff. of Breakdown Voltage	$V_{GE} = 0V, I_C = 1mA$	-	0.6	-	V/°C
$V_{GE(th)}$	G - E threshold voltage	$I_C = 2.0mA, V_{CE} = V_{GE}$	5	-	8	V
I_{CES}	Collector cutoff Current	$V_{CE} = 1200V, V_{GE} = 0V$	-	-	1.0	mA
I_{GES}	G - E leakage Current	$V_{GE} = \pm 20V$	-	-	± 200	nA
$V_{CE(sat)}$	Collector to Emitter saturation voltage	$I_C=100A, V_{GE}=15V @T_C= 25^\circ\text{C}$	-	1.8	2.5	V
		$I_C=100A, V_{GE}=15V @T_C=100^\circ\text{C}$	-	2.0	-	V
C_{ies}	Input capacitance	$V_{GE} = 0V, f = 1MHz$	-	7.43	-	nF
C_{oes}	Output capacitance	$V_{CE} = 25V$	-	0.52	-	nF
C_{res}	Reverse transfer capacitance		-	0.34	-	nF
$t_{d(on)}$	Turn on delay time	$V_{CC} = 600V, I_C = 100A$	-	125	-	nS
t_r	Turn on rise time	$V_{GE} = \pm 15V$	-	60	-	nS
$t_{d(off)}$	Turn off delay time	$R_G = 6.8\Omega$	-	420	-	nS
t_f	Turn off fall time	Inductive Load	-	60	-	nS
E_{on}	Turn on Switching Loss		-	8.6	-	mJ
E_{off}	Turn off Switching Loss		-	6.8	-	mJ
E_{ts}	Total Switching Loss		-	15.4	-	mJ
T_{sc}	Short Circuit Withstand Time	$V_{CC} = 600V, V_{GE} = \pm 15V$ $R_G = 6.8\Omega @T_C = 100^\circ\text{C}$	10	-	-	μS
Q_g	Total Gate Charge	$V_{CC} = 600V$	-	1050	-	nC
Q_{ge}	Gate-Emitter Charge	$V_{GE} = \pm 15V$	-	90	-	nC
Q_{gc}	Gate-Collector Charge	$I_C = 100A$	-	450	-	nC

Electrical Characteristics of FRD @ $T_c=25^\circ\text{C}$ (unless otherwise specified)

Symbol	Parameter	Conditions	Values			Unit	
			Min.	Typ.	Max.		
V_{FM}	Diode Forward Voltage	$I_F = 100\text{A}$	$T_c = 25^\circ\text{C}$	-	2.1	3.0	V
			$T_c = 100^\circ\text{C}$	-	2.0	-	
t_{rr}	Diode Reverse	$I_F = 100\text{A}, V_R = 600\text{V}$ $di/dt = -200\text{A}/\mu\text{S}$	$T_c = 25^\circ\text{C}$	-	140	-	nS
	Recovery Time		$T_c = 100^\circ\text{C}$	-	155	-	
I_{rr}	Diode Peak Reverse		$T_c = 25^\circ\text{C}$	-	35	-	A
	Recovery Current		$T_c = 100^\circ\text{C}$	-	48	-	
Q_{rr}	Diode Reverse		$T_c = 25^\circ\text{C}$	-	2300	-	nC
	Recovery Charge		$T_c = 100^\circ\text{C}$	-	8900	-	

Thermal Characteristics and Weight

Symbol	Parameter	Conditions	Values			Unit
			Min.	Typ.	Max.	
$R_{\theta JC}$	Junction-to-Case(IGBT Part, Per 1/2 Module)		-	-	0.18	$^\circ\text{C}/\text{W}$
$R_{\theta JC}$	Junction-to-Case(DIODE Part, Per 1/2 Module)		-	-	0.45	$^\circ\text{C}/\text{W}$
$R_{\theta CS}$	Case-to-Sink (Conductive grease applied)		0.05	-	-	$^\circ\text{C}/\text{W}$
Weight	Weight of Module		-	-	200	g

Performance Curves

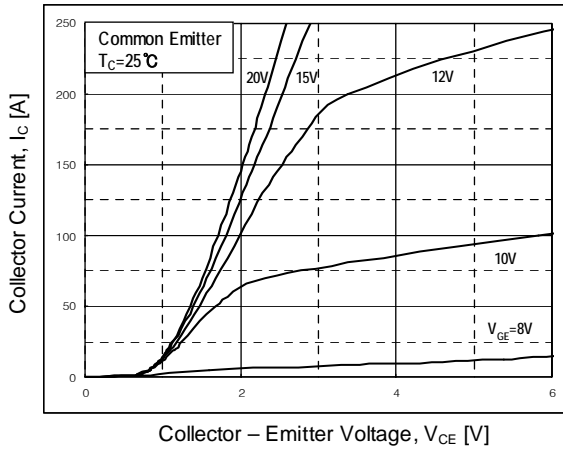

Fig 1. Typical Output characteristics

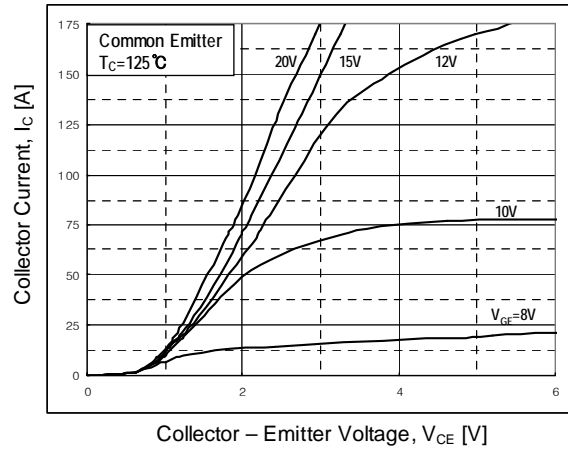

Fig 2. Typical Output characteristics

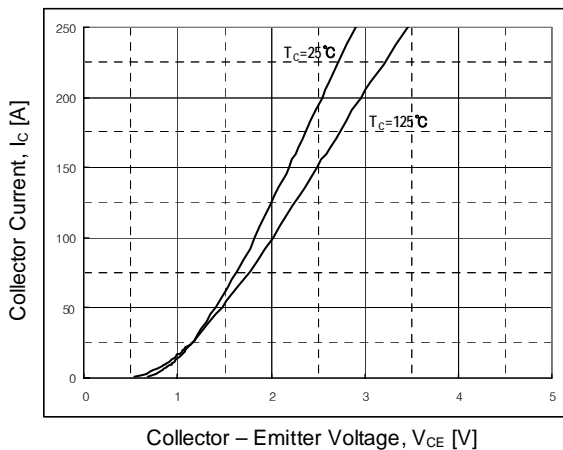

Fig 3. Typical Saturation Voltage characteristics

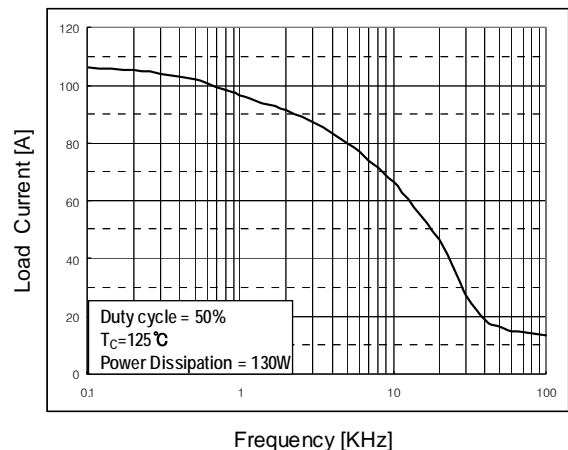

Fig 4. Load Current vs. Frequency

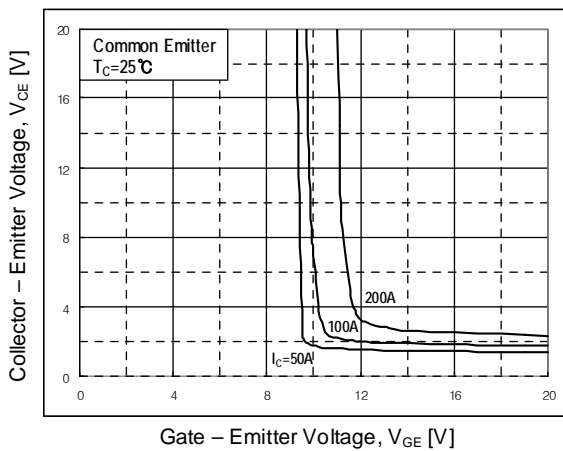

Fig 5. Typical Saturation Voltage vs. V_{CE}

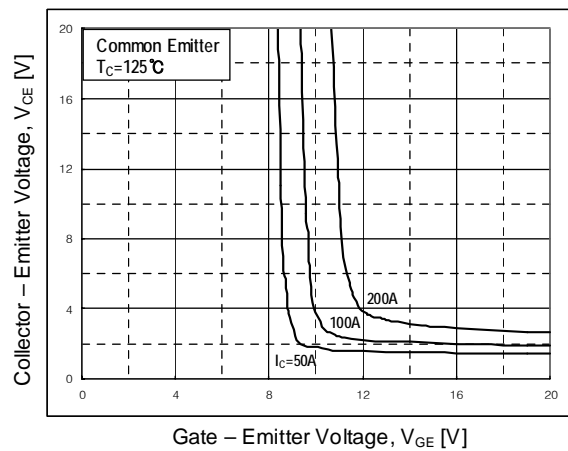
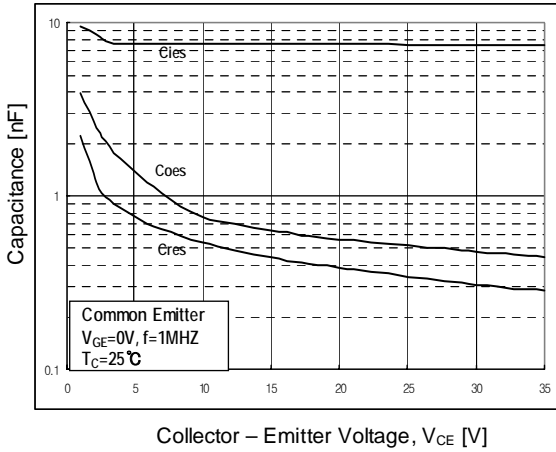
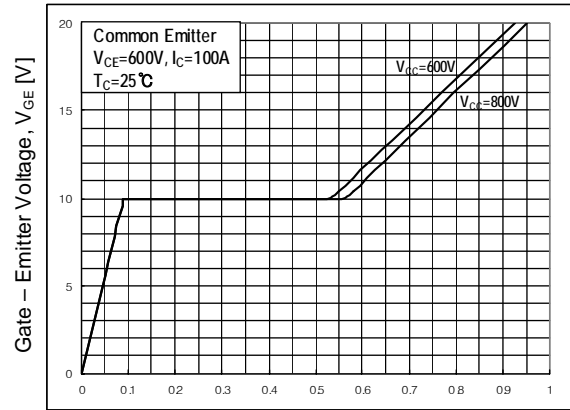

Fig 6. Typical Saturation Voltage vs. V_{CE}



Collector - Emitter Voltage, V_{CE} [V]
Fig 7. Capacitance characteristics



Gate Charge, Q_g [nC]
Fig 8. Gate Charge characteristics

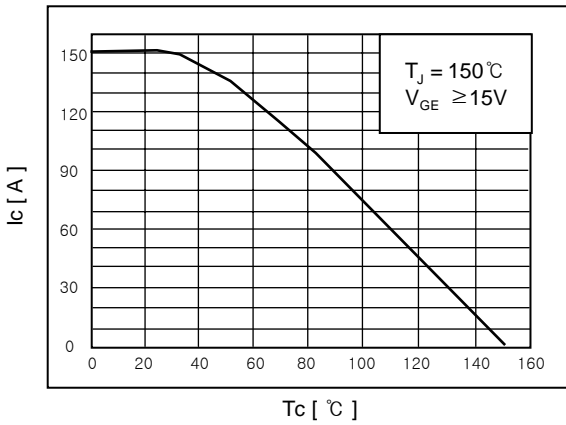

Fig 9. rated Current vs. Case Temperature

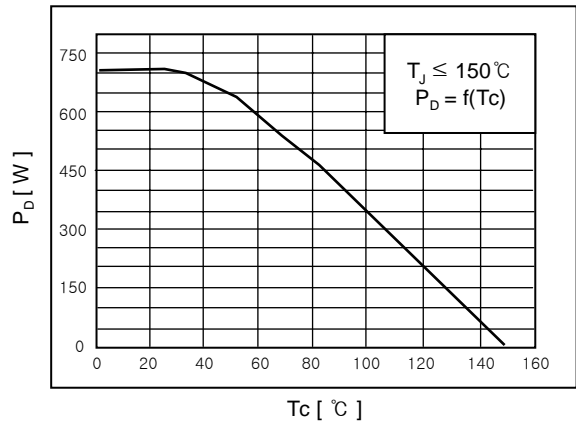
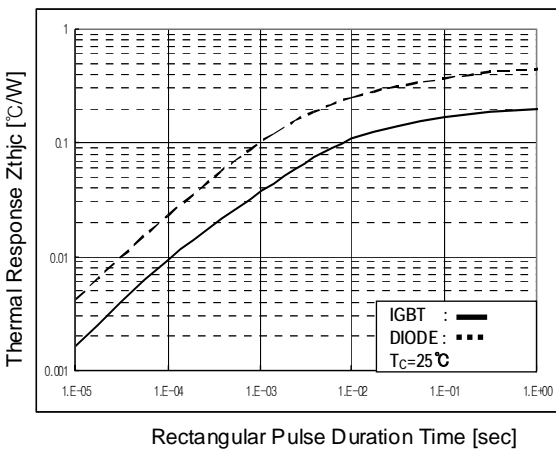
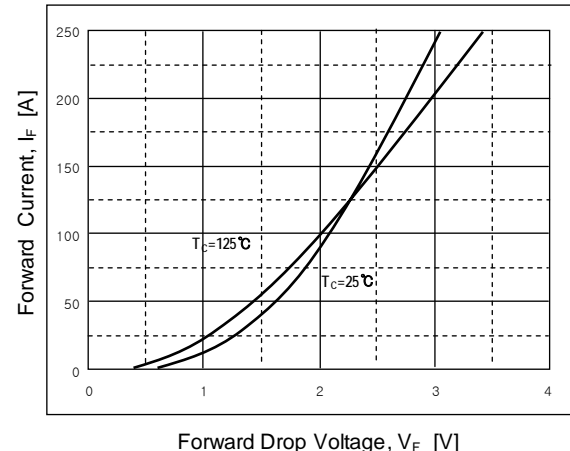

Fig 10. Power Dissipation vs. Case Temperature



Rectangular Pulse Duration Time [sec]
Fig 11. Transient Thermal Impedance



Forward Drop Voltage, V_F [V]
Fig 12. Forward characteristics

Package Out Line Information

7DM-1

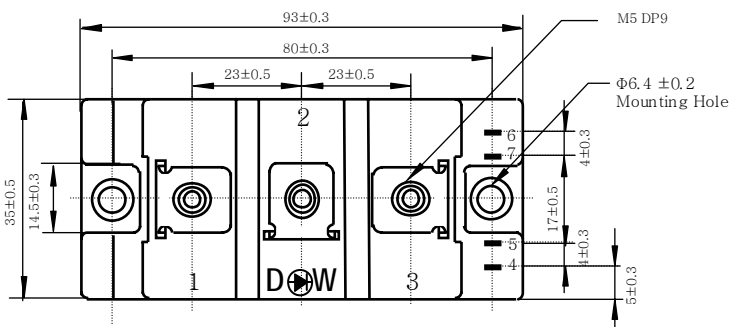

Dimensions in mm

