



FDA8440

N-Channel PowerTrench® MOSFET

40V, 100A, 2.1mΩ

Features

- $R_{DS(on)} = 1.46m\Omega$ (Typ.)@ $V_{GS} = 10V, I_D = 80A$
- $Q_{g(tot)} = 345nC$ (Typ.)@ $V_{GS} = 10V$
- Low Miller Charge
- Low QRR Body Diode
- UIS Capability (Single Pulse and Repetitive Pulse)
- 160A Guarantee for 2 sec
- RoHS Compliant



Application

- Automotive Engine Control
- Powertrain Management
- Motors, Solenoids
- Electronic Steering
- Integrated Starter/ Alternator
- Distributed Power Architectures and VRMs
- Primary Switch for 12V systems

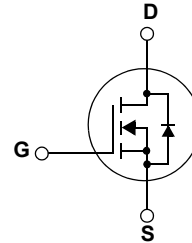
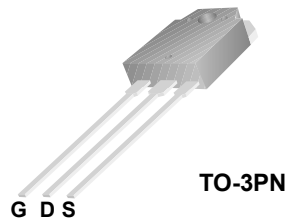

MOSFET Maximum Ratings $T_C = 25^\circ C$ unless otherwise noted

Symbol	Parameter	Ratings	Units
V_{DSS}	Drain to Source Voltage	40	V
V_{GSS}	Gate to Source Voltage	± 20	V
I_D	Drain Current - Continuous ($T_C = 145^\circ C$)	100	A
	- Continuous ($T_A = 25^\circ C, V_{GS} = 10V, R_{\theta JA} = 40^\circ C/W$)	30	A
	- Pulsed	500	A
E_{AS}	Single Pulsed Avalanche Energy (Note 1)	410	mJ
P_D	Power dissipation	250	W
	Derate above $25^\circ C$	1.67	mW/ $^\circ C$
T_J, T_{STG}	Operating and Storage Temperature	-55 to +175	$^\circ C$

Thermal Characteristics

$R_{\theta JC}$	Thermal Resistance, Junction to Case	0.6	$^\circ C/W$
$R_{\theta JA}$	Thermal Resistance, Junction to Ambient (Note 2)	40	$^\circ C/W$

Package Marking and Ordering Information

Device Marking	Device	Package	Reel Size	Tape Width	Quantity
FDA8440	FDA8440	TO-3PN	N/A	N/A	30units

Electrical Characteristics T_C = 25°C unless otherwise noted

Symbol	Parameter	Conditions	Min	Typ	Max	Units	
Off Characteristics							
BV _{DSS}	Drain to Source Breakdown Voltage	V _{GS} = 0V, I _D = 250μA	40	--	--	V	
I _{DSS}	Zero Gate Voltage Drain Current	V _{DS} = 32V	--	--	1	μA	
		V _{GS} = 0V	T _C = 150°C	--	--	250	μA
I _{GSS}	Gate to Body Leakage Current	V _{GS} = ±20V	--	--	±100	nA	
On Characteristics							
V _{GS(th)}	Gate to Source Threshold Voltage	V _{DS} = V _{GS} , I _D = 250μA	1	--	3	V	
R _{DS(on)}	Static Drain-Source On-Resistance	V _{GS} = 4.5V, I _D = 80A	--	1.56	2.2	mΩ	
		V _{GS} = 10V, I _D = 80A	--	1.46	2.1		
		V _{GS} = 10V, I _D = 80A, T _C = 175°C	--	2.82	4.1		
Dynamic Characteristics							
C _{iss}	Input Capacitance	V _{DS} = 25V, V _{GS} = 0V, f = 1.0MHz	--	18600	24740	pF	
C _{oss}	Output Capacitance		--	1840	2450	pF	
C _{rss}	Reverse Transfer Capacitance		--	1400	2100	pF	
R _G	Gate Resistance	V _{GS} = 0.5V, f = 1MHz	--	1.1	--	Ω	
Q _{g(tot)}	Total Gate Charge at 10V	V _{GS} = 0V to 10V	V _{DD} = 20V I _D = 80A I _g = 1.0mA	--	345	450	nC
Q _{g(2)}	Threshold Gate Charge	V _{GS} = 0V to 2V		--	32.5	--	nC
Q _{gs}	Gate to Source Gate Charge			--	49	--	nC
Q _{gs2}	Gate Charge Threshold to Plateau			--	42	--	nC
Q _{gd}	Gate to Drain "Miller" Charge			--	74	--	nC
Switching Characteristics (V_{GS} = 10V)							
t _{ON}	Turn-On Time	V _{DD} = 20V, I _D = 80A V _{GS} = 10V, R _{GEN} = 7Ω	--	175	360	ns	
t _{d(on)}	Turn-On Delay Time		--	43	95	ns	
t _r	Rise Time		--	130	275	ns	
t _{d(off)}	Turn-Off Delay Time		--	435	875	ns	
t _f	Fall Time		--	290	590	ns	
t _{OFF}	Turn-Off Time		--	730	1470	ns	
Drain-Source Diode Characteristics and Maximum Ratings							
V _{SD}	Source to Drain Diode Voltage	I _{SD} = 80A	--	--	1.25	V	
		I _{SD} = 40A	--	--	1.0	V	
t _{rr}	Reverse Recovery Time	I _{SD} = 75A, dI _{SD} /dt = 100A/μs	--	59	--	ns	
Q _{RR}	Reverse Recovery Charge	I _{SD} = 75A, dI _{SD} /dt = 100A/μs	--	77	--	nC	

NOTES:

1: Starting T_J = 25°C, L = 200μH, I_{AS} = 64A, V_{DD} = 36V, V_{GS} = 10V.

2: Pulse width = 100s

Typical Performance Characteristics

Figure 1. On-Region Characteristics

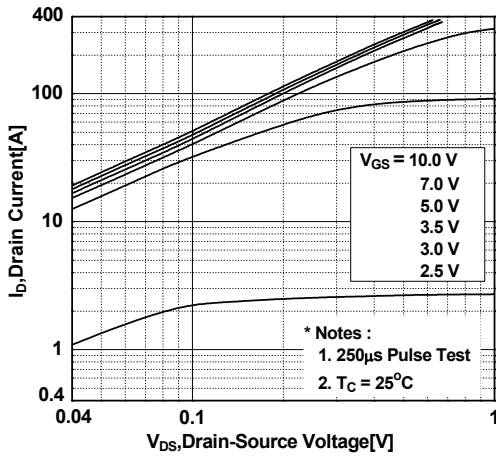

Figure 2. Transfer Characteristics

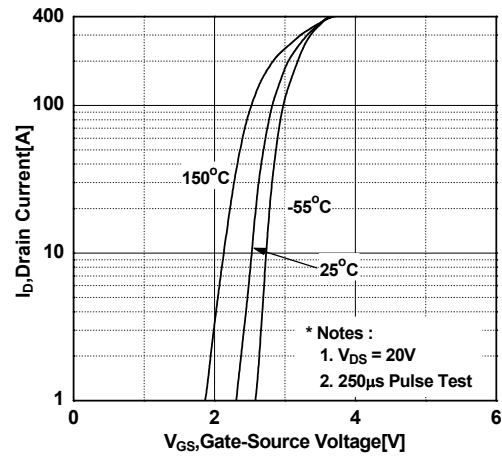

Figure 3. On-Resistance Variation vs. Drain Current and Gate Voltage

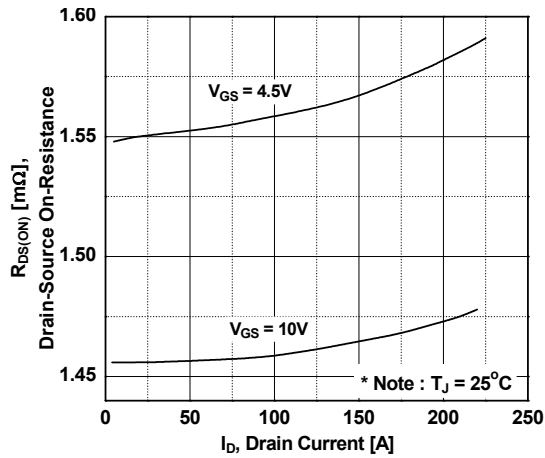

Figure 4. Body Diode Forward Voltage Variation vs. Source Current and Temperature

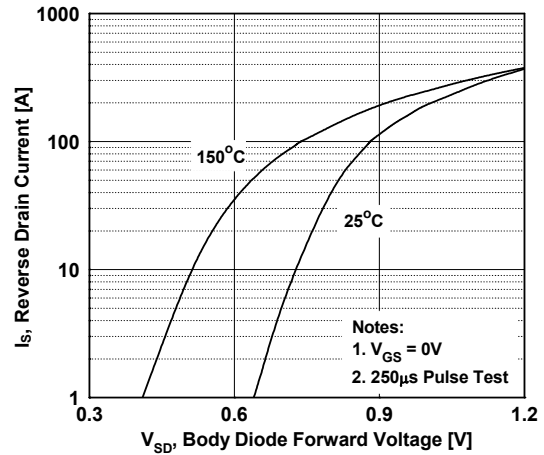

Figure 5. Capacitance Characteristics

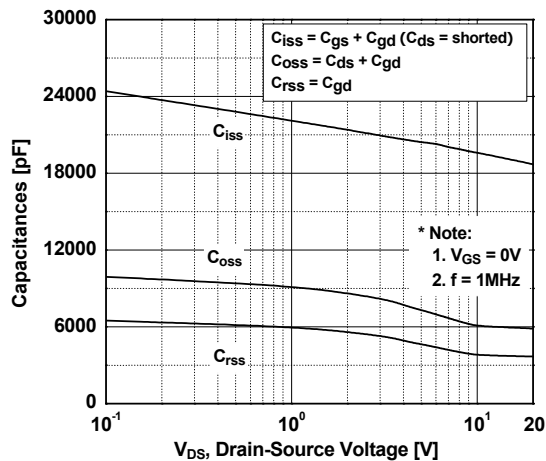
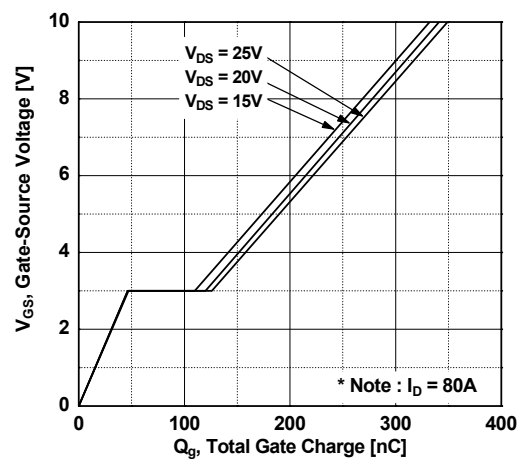

Figure 6. Gate Charge Characteristics



Typical Performance Characteristics (Continued)

Figure 7. Breakdown Voltage Variation vs. Temperature

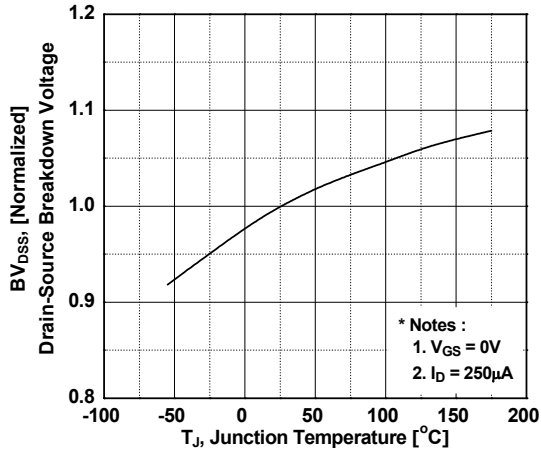

Figure 8. On-Resistance Variation vs. Temperature

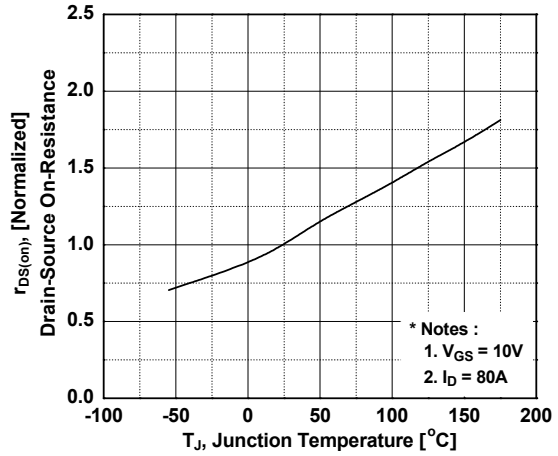

Figure 9. Unclamped Inductive Switching Capability

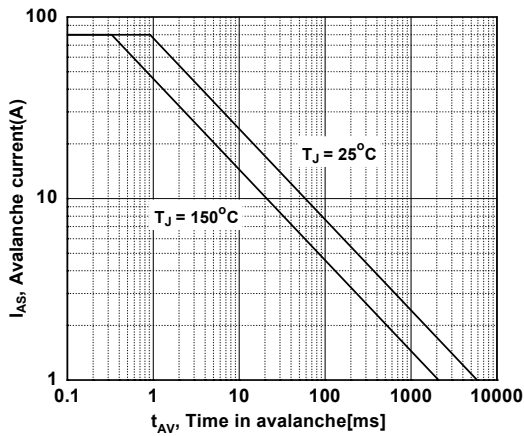

Figure 10. Safe Operating Area

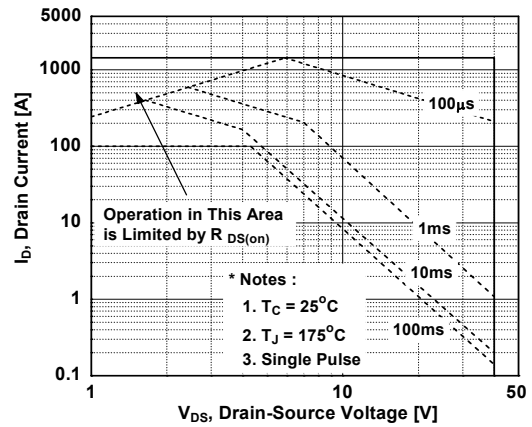
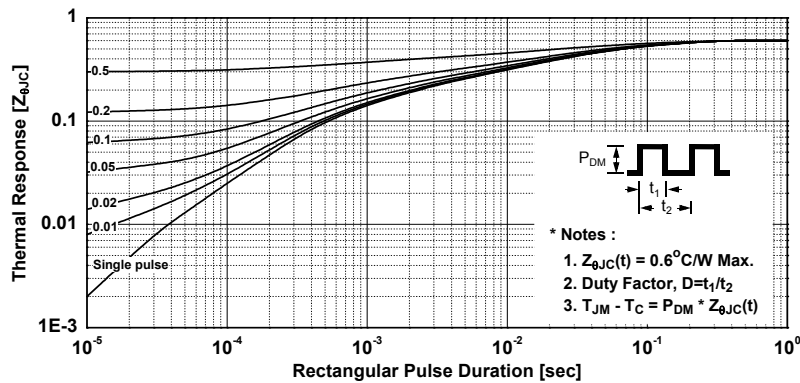
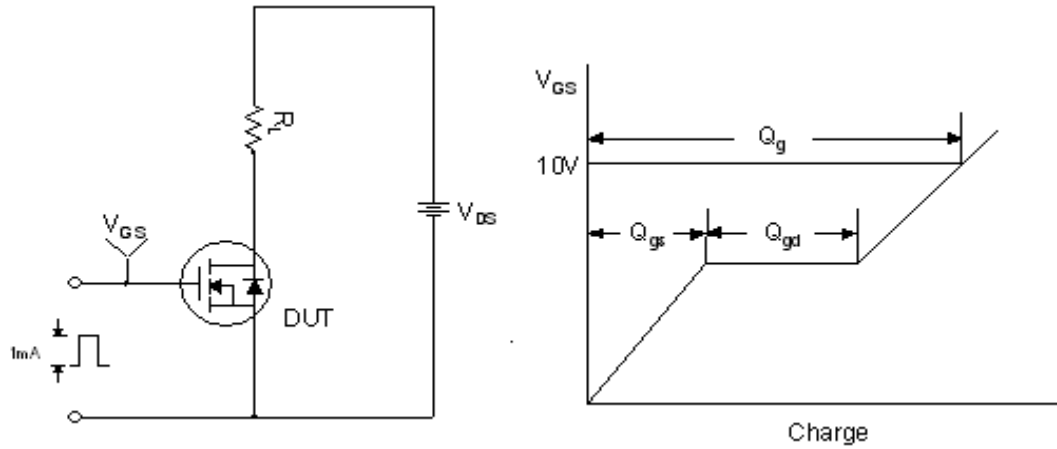

Figure 11. Transient Thermal Response Curve



Gate Charge Test Circuit & Waveform



Resistive Switching Test Circuit & Waveforms

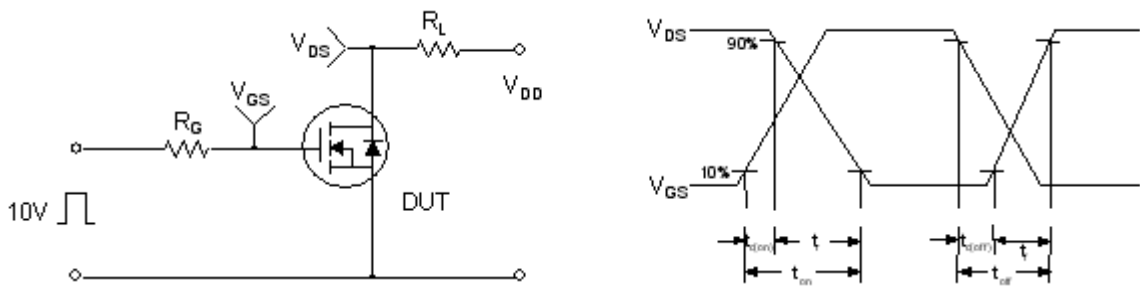

Unclamped Inductive Switching Test Circuit & Waveforms

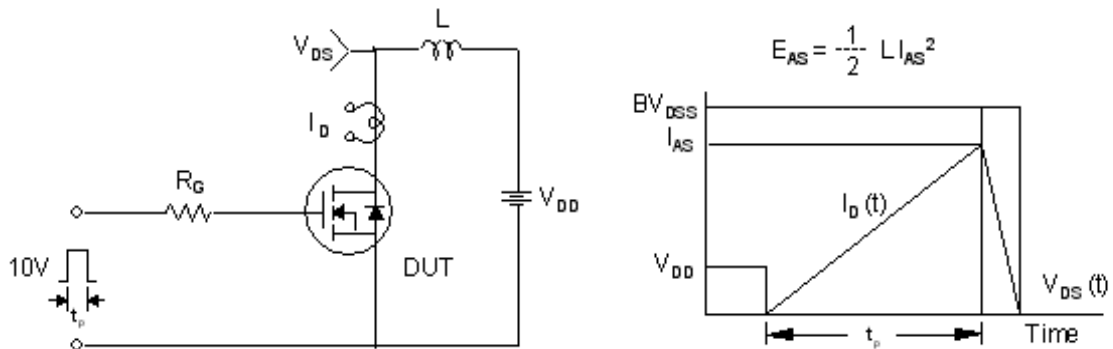

Peak Diode Recovery dv/dt Test Circuit & Waveforms



Mechanical Dimensions

TO-3PN

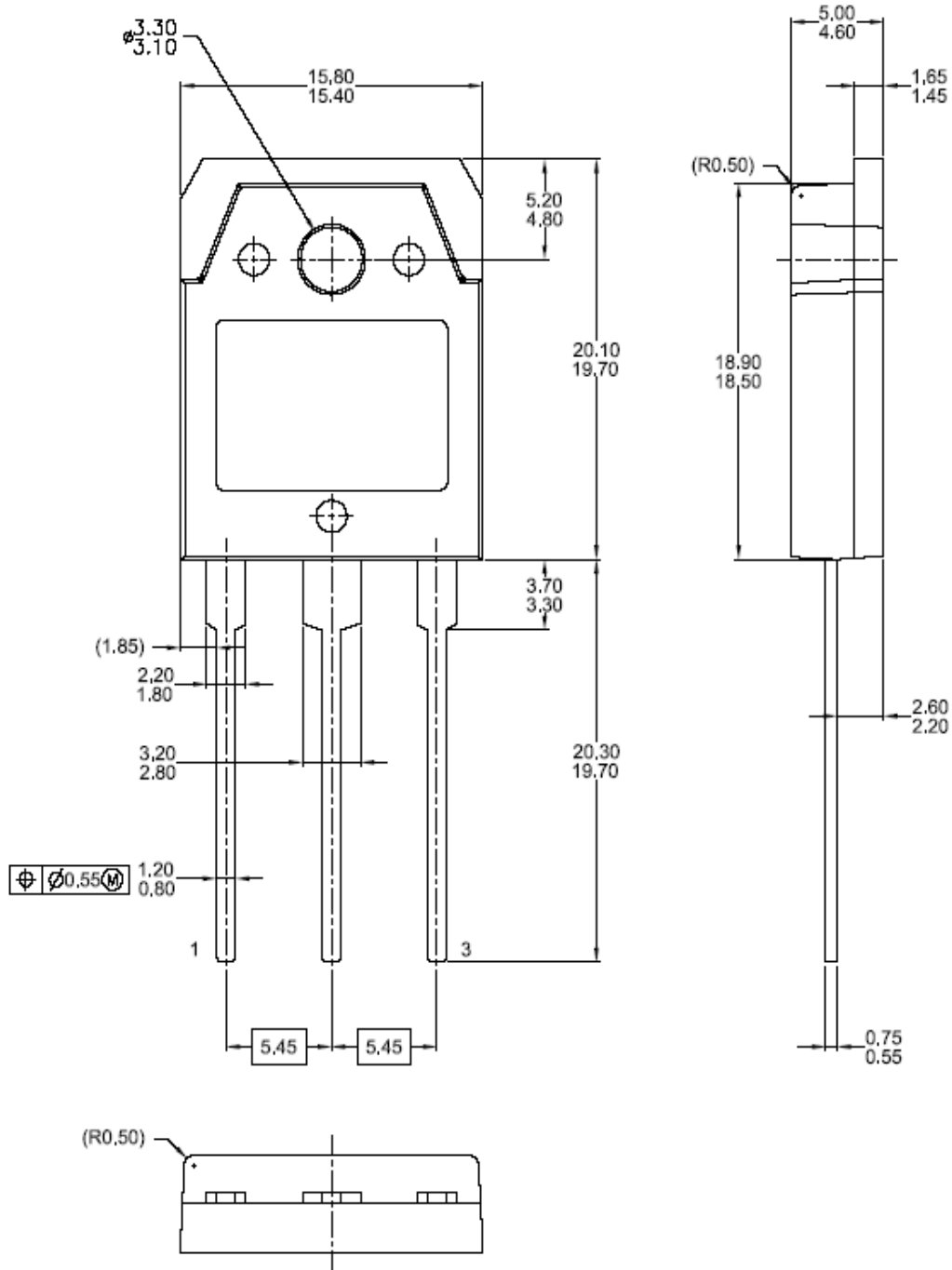

Dimensions in Millimeters



TRADEMARKS

The following are registered and unregistered trademarks Fairchild Semiconductor owns or is authorized to use and is not intended to be an exhaustive list of all such trademarks.

ACEx®	HiSeC™	Programmable Active Droop™	TinyLogic®
Across the board. Around the world.™	<i>i-Lo</i> ™	QFET®	TINYOPTO™
ActiveArray™	ImpliedDisconnect™	QS™	TinyPower™
Bottomless™	IntelliMAX™	QT Optoelectronics™	TinyWire™
Build it Now™	ISOPLANAR™	Quiet Series™	TruTranslation™
CoolFET™	MICROCOUPLER™	RapidConfigure™	µSerDes™
CROSSVOLT™	MicroPak™	RapidConnect™	UHC®
CTL™	MICROWIRE™	ScalarPump™	UniFET™
Current Transfer Logic™	MSX™	SMART START™	VCX™
DOME™	MSXPro™	SPM®	Wire™
E ² CMOS™	OCX™	STEALTH™	
EcoSPARK®	OCXPro™	SuperFET™	
EnSigna™	OPTOLOGIC®	SuperSOT™-3	
FACT Quiet Series™	OPTOPLANAR®	SuperSOT™-6	
FACT®	PACMAN™	SuperSOT™-8	
FAST®	POP™	SyncFET™	
FASTr™	Power220®	TCM™	
FPS™	Power247®	The Power Franchise®	
FRFET®	PowerEdge™	⏻™	
GlobalOptoisolator™	PowerSaver™	TinyBoost™	
GTO™	PowerTrench®	TinyBuck™	

DISCLAIMER

FAIRCHILD SEMICONDUCTOR RESERVES THE RIGHT TO MAKE CHANGES WITHOUT FURTHER NOTICE TO ANY PRODUCTS HEREIN TO IMPROVE RELIABILITY, FUNCTION OR DESIGN. FAIRCHILD DOES NOT ASSUME ANY LIABILITY ARISING OUT OF THE APPLICATION OR USE OF ANY PRODUCT OR CIRCUIT DESCRIBED HEREIN; NEITHER DOES IT CONVEY ANY LICENSE UNDER ITS PATENT RIGHTS, NOR THE RIGHTS OF OTHERS. THESE SPECIFICATIONS DO NOT EXPAND THE TERMS OF FAIRCHILD'S WORLDWIDE TERMS AND CONDITIONS, SPECIFICALLY THE WARRANTY THEREIN, WHICH COVERS THESE PRODUCTS.

LIFE SUPPORT POLICY

FAIRCHILD'S PRODUCTS ARE NOT AUTHORIZED FOR USE AS CRITICAL COMPONENTS IN LIFE SUPPORT DEVICES OR SYSTEMS WITHOUT THE EXPRESS WRITTEN APPROVAL OF FAIRCHILD SEMICONDUCTOR CORPORATION.

As used herein:

1. Life support devices or systems are devices or systems which, (a) are intended for surgical implant into the body or (b) support or sustain life, and (c) whose failure to perform when properly used in accordance with instructions for use provided in the labeling, can be reasonably expected to result in a significant injury of the user.
2. A critical component in any component of a life support, device, or system whose failure to perform can be reasonably expected to cause the failure of the life support device or system, or to affect its safety or effectiveness.

PRODUCT STATUS DEFINITIONS

Definition of Terms

Datasheet Identification	Product Status	Definition
Advance Information	Formative or In Design	This datasheet contains the design specifications for product development. Specifications may change in any manner without notice.
Preliminary	First Production	This datasheet contains preliminary data; supplementary data will be published at a later date. Fairchild Semiconductor reserves the right to make changes at any time without notice to improve design.
No Identification Needed	Full Production	This datasheet contains final specifications. Fairchild Semiconductor reserves the right to make changes at any time without notice to improve design.
Obsolete	Not In Production	This datasheet contains specifications on a product that has been discontinued by Fairchild Semiconductor. The datasheet is printed for reference information only.

Rev. I24